

# D-Torch with Quartz Outer Tube for Optima 7300V

## 30-808-2832



Also suitable for Optima 5300V and Optima 4300V

### BEFORE YOU START

Congratulations on the purchase of your D-Torch.

For your reference, the D-Torch is made up of three components; these can be ordered separately, refer Table 1

D-torch is supplied with a pair of gloves; always wear clean gloves when handling ICP Torches and their components

Item No.	Part Number	Description	Qty
1	31-808-2809	Base and Inner Tube	1
2	31-808-2821	Quartz Outer Tube	1
3	31-808-2818	Retainer	1
4	SAFEGLOVE-MED	Safety Gloves	1

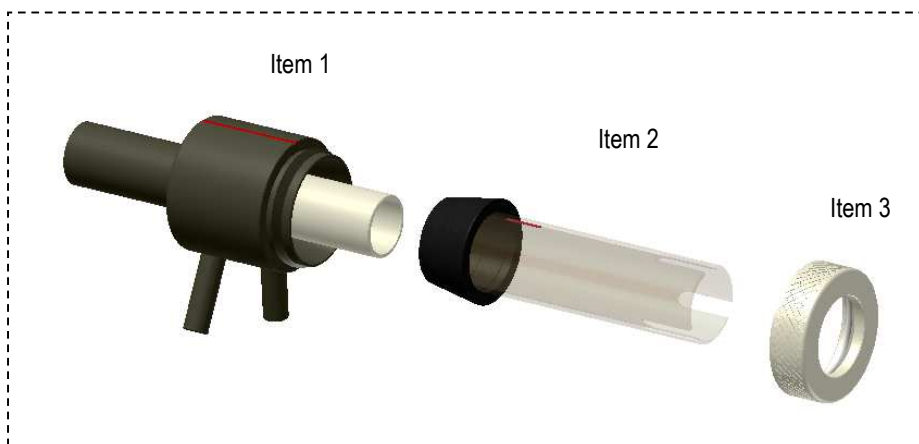

### Scope

1. Precautions for personal safety and Torch preservation
2. How to remove Outer Tube from Torch
3. How to re-attach Outer Tube to Torch

### Special tools, requirements, etc

- Safety glasses
- Safety gloves (Item 4 Supplied)
- Basic competence in making connections to ICP

#### 1. Precautions for personal safety and Torch preservation

- Always wear safety gloves and glasses when removing (or replacing) ICP Torches.
- The Torch is made from high grade engineered materials – Handle with extreme care
- Do not allow the Torch to be placed on hard surfaces or allow it to come into contact with hard objects

**Note!** It is recommend you review and understand this procedure before handling the Torch assembly

# D-Torch with Quartz Outer Tube for Optima 7300V

## 30-808-2832

### 2. How to remove Outer Tube

The Torch outer tube is accurately located in place with the retainer. The outer tube can be removed at any time by completing the following steps.

Note! A tapered ferrule is permanently fixed to the outer tube – Do not attempt to remove the ferrule from the tube.

Step 2.1. If fitted, remove Torch assembly from ICP. (Not Shown)

Step 2.2. Unscrew Retainer ½ turn

Step 2.3. Grip outer tube (lower end, near D-Torch body) then wriggle tube from side to side – refer figure 2.3  
You will hear a “click” as the outer tube releases

Step 2.4. Fully unscrew the Retainer then carefully withdraw the Outer Tube from the Torch Body

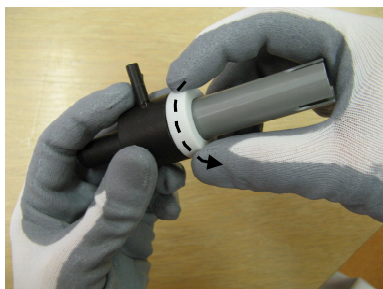

Step 2.2.

(Note! Photos show ceramic type Outer Tube)

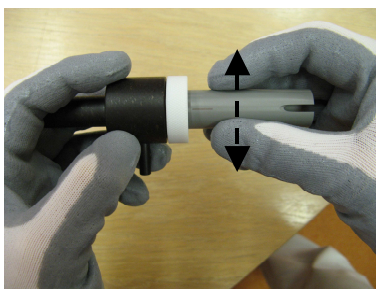

Step 2.3.

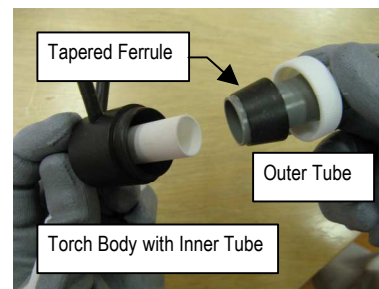

Step 2.4.

### 3. How to re-attach Outer Tube

To replace the outer Tube, complete the following steps.

Step 3.1. Check that both locating surfaces (Outer Tube and Torch body) are clean and free of damage.

Step 3.2. Carefully slide the Outer Tube over the Inner Tube – The Outer Tube will self locate into the Torch body.

Step 3.3. Tighten the Retainer to fix the Outer Tube in place (Moderate pressure by hand is adequate).

Step 3.4. If desired, return Torch assembly to ICP and connect as normal. (Not Shown)

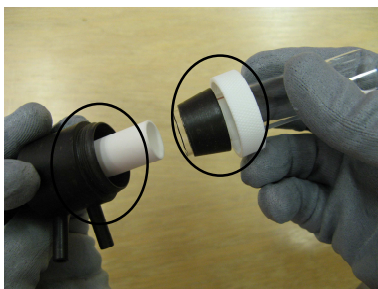

Step 3.1.

(Note! Photos show quartz type Outer Tube)

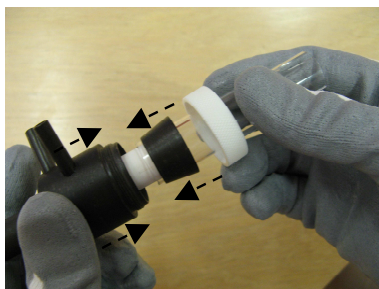

Step 3.2.

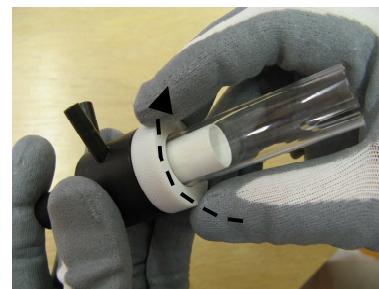

Step 3.3.

**Note!** If you have any questions regarding your D-Torch assembly or this procedure, please contact Glass Expansion